

# RESISTANCE TEMPERATURE DETECTORS [5]

## HEAD TERMINATIONS

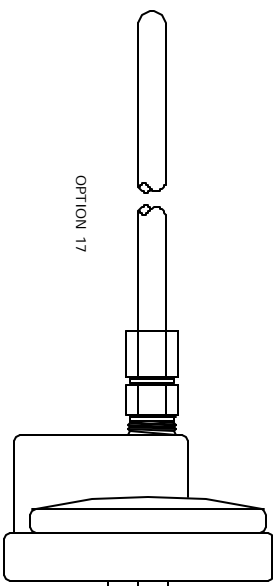

OPTION 17

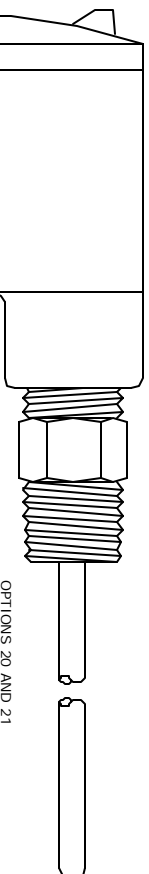

OPTIONS 20 AND 21

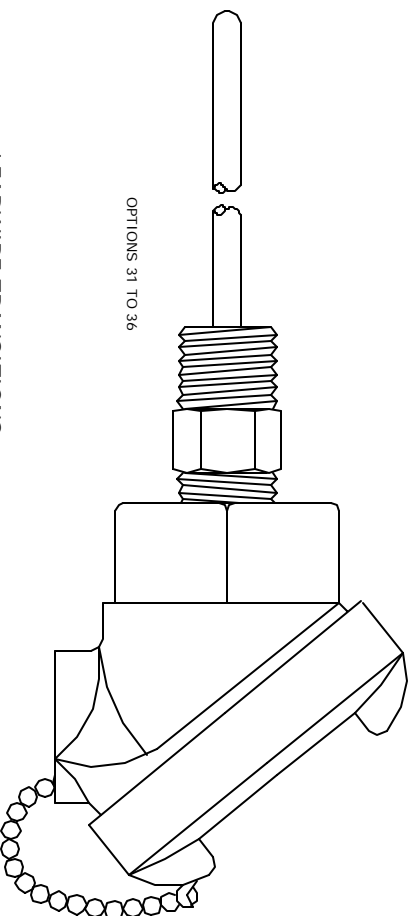

OPTIONS 31 TO 36

## LEADWIRE TRANSITIONS

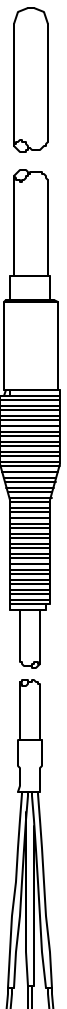

OPTION 15

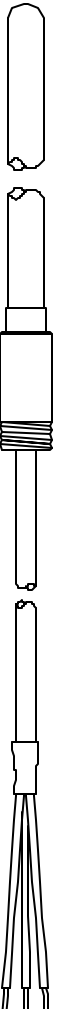

OPTION 15H

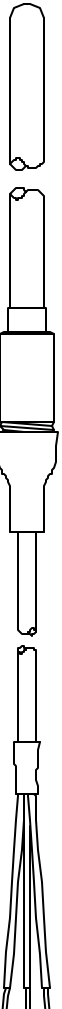

OPTION 16

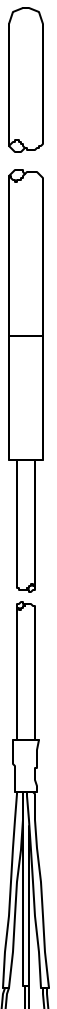

OPTION 19